

Distribution and number of marine mammals in the open Barents Sea and their connection with capelin and polar cod distribution.

***V. Zabavnikov*, S. Ziryanov*, V. Tereschenko*,
K. Nilssen** and U. Lindstrøm*****

*Polar Institute of Fisheries and Oceanography
(PINRO), Murmansk, Russia

**Institute of Marine Research, Bergen, Norway



Legend

 ice edge

 shore

 economical zones

 areal of minke whale

 areal of humpback whale

 areal of harp seals

 areal of white beaked dolphin

 others and unidentified cetaceans

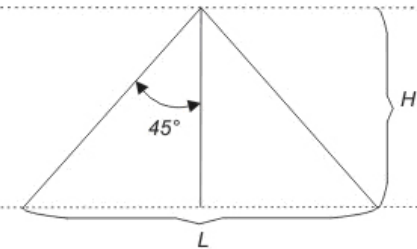
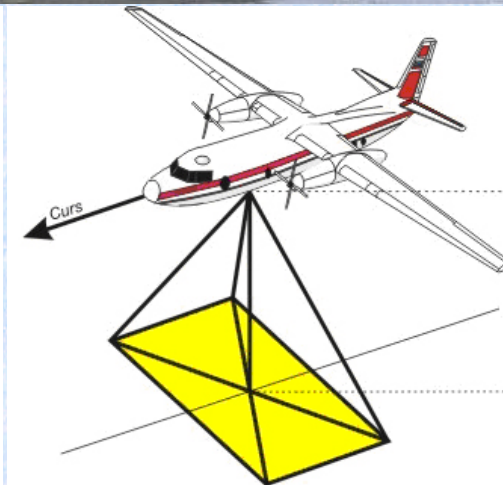

distribution of capeline

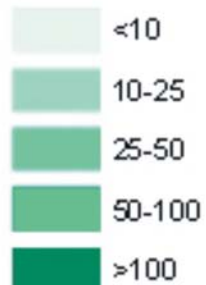

distribution of polar cod

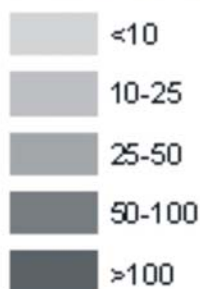

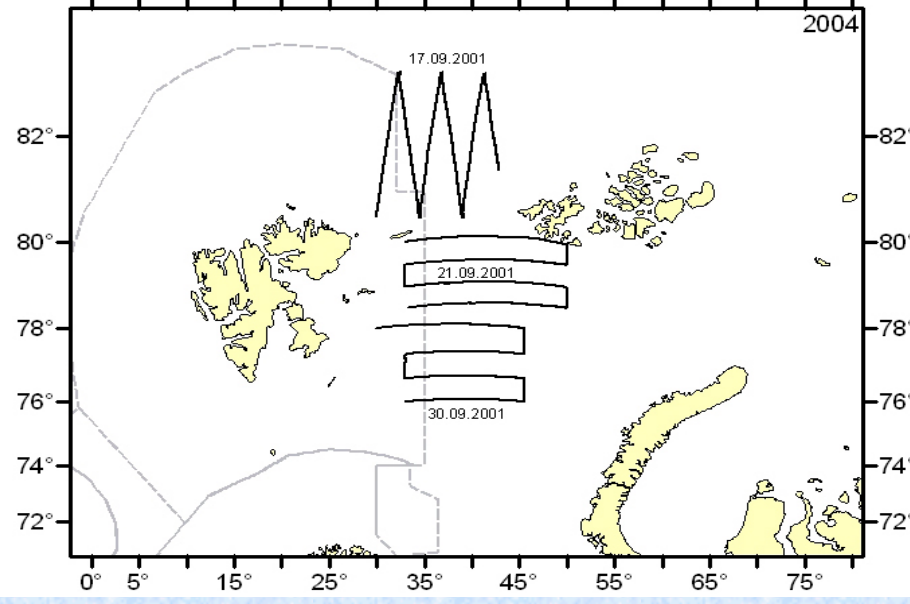
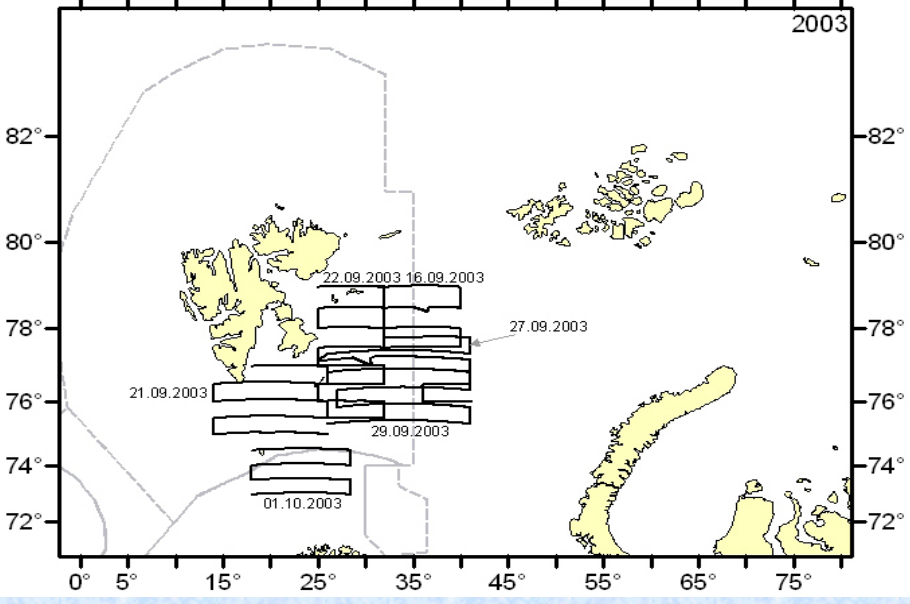
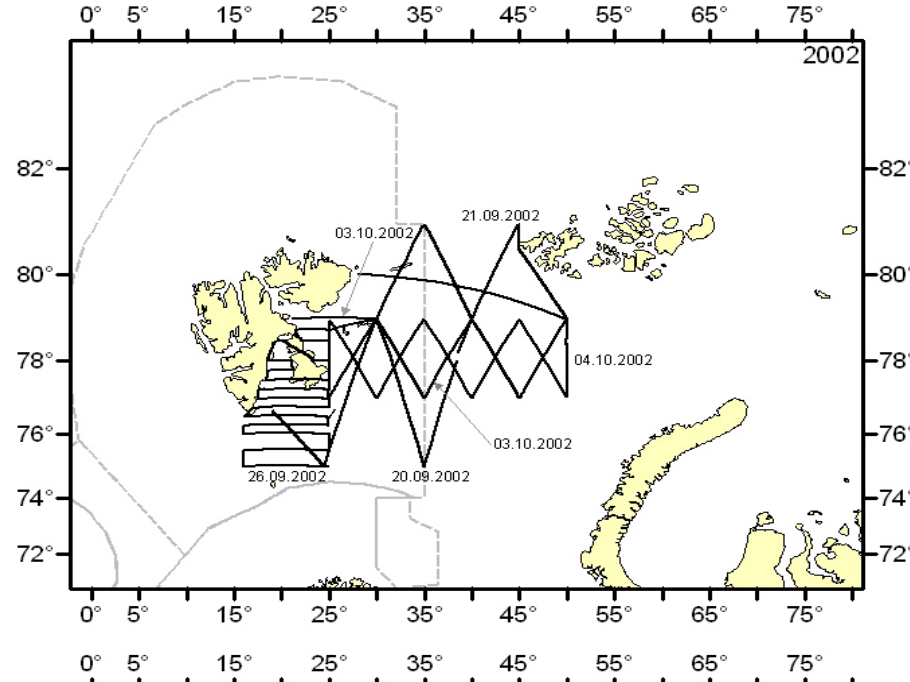
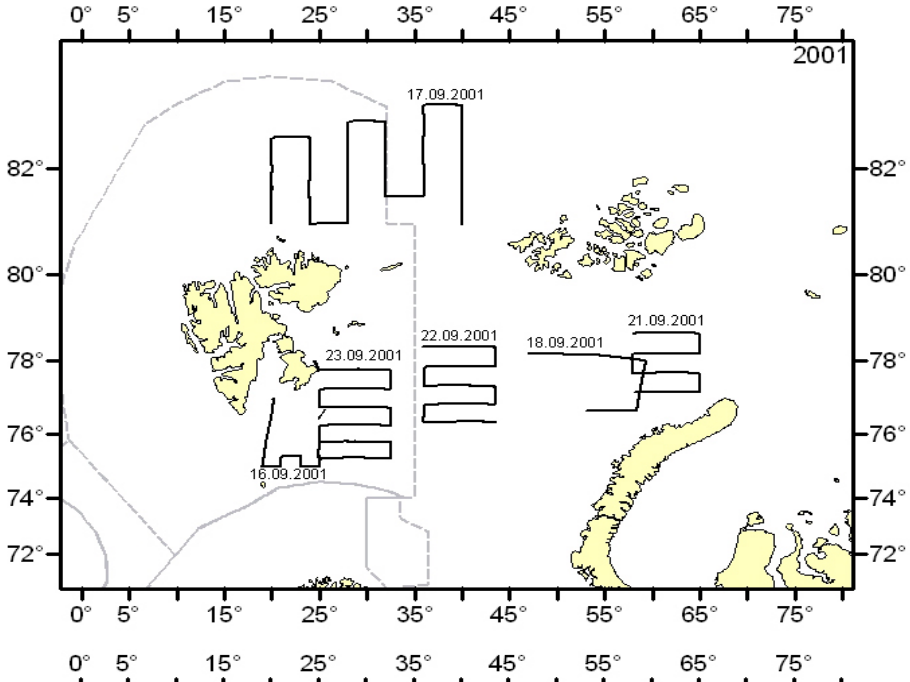

Situation of transects of air surveys 2001-2004.

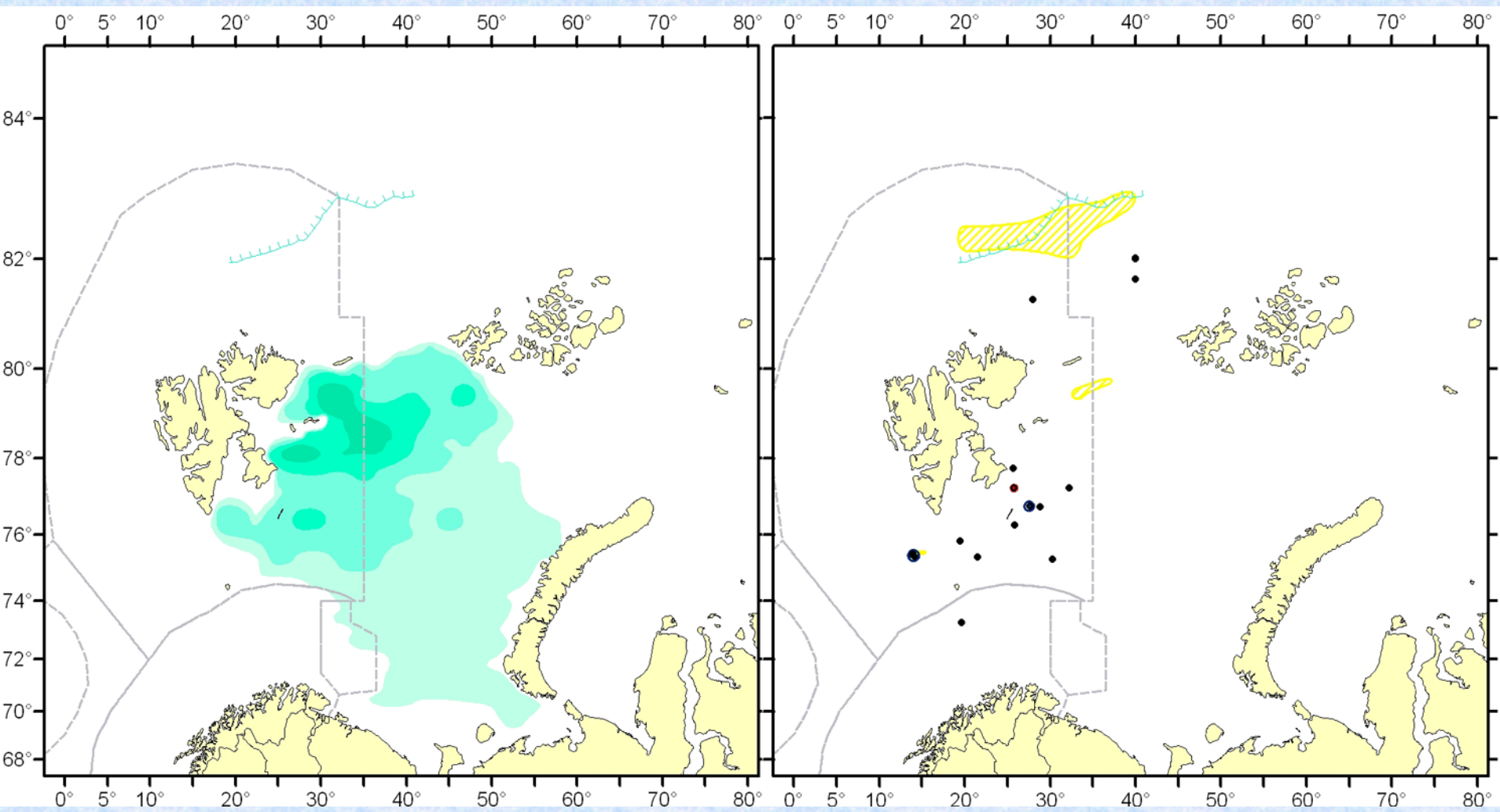

Distribution of capelin and marine mammals in the open part of the Barents Sea during autumn 2001.

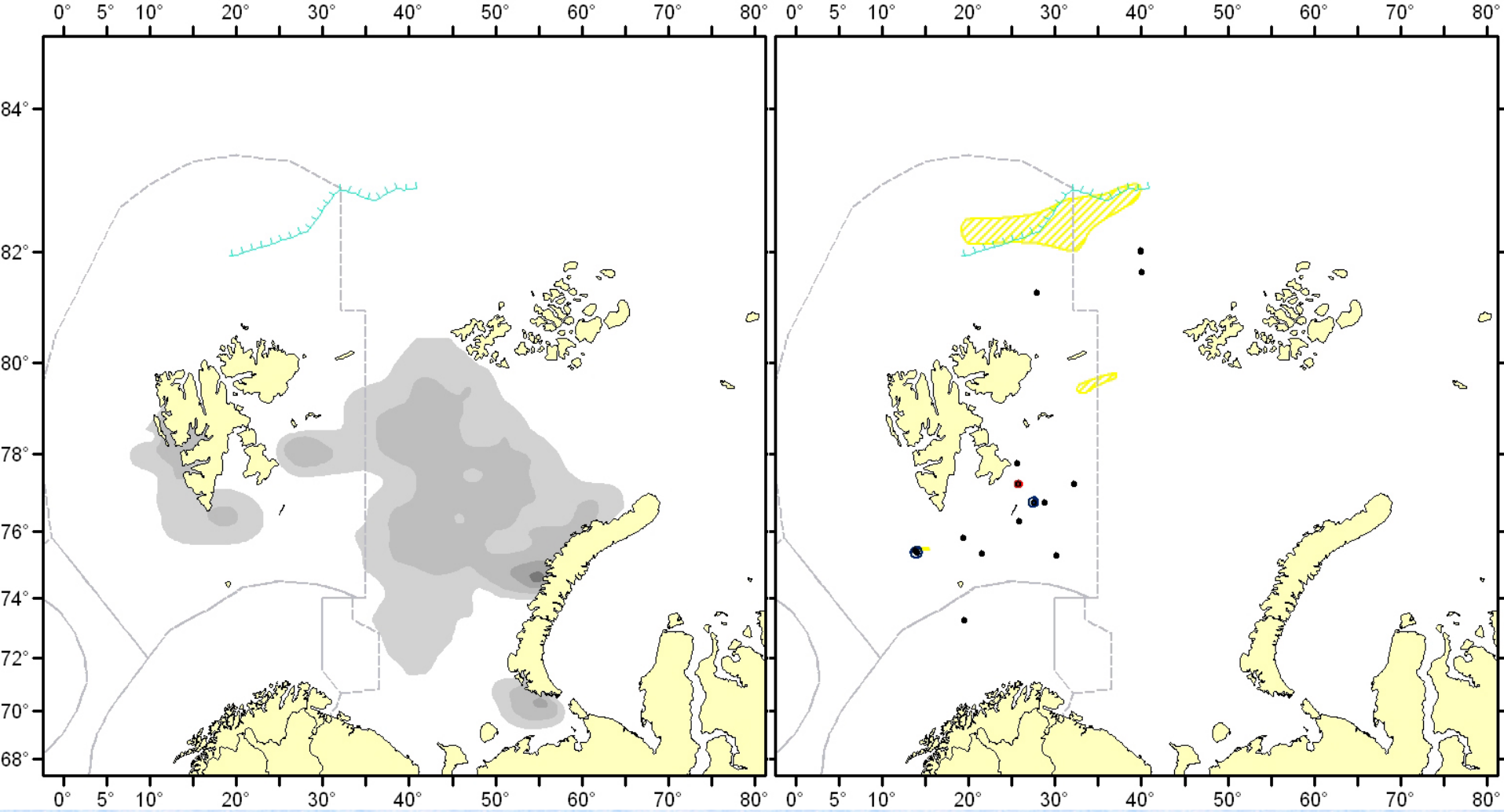

Distribution of polar cod and marine mammals in the open part of the Barents Sea during autumn 2001.

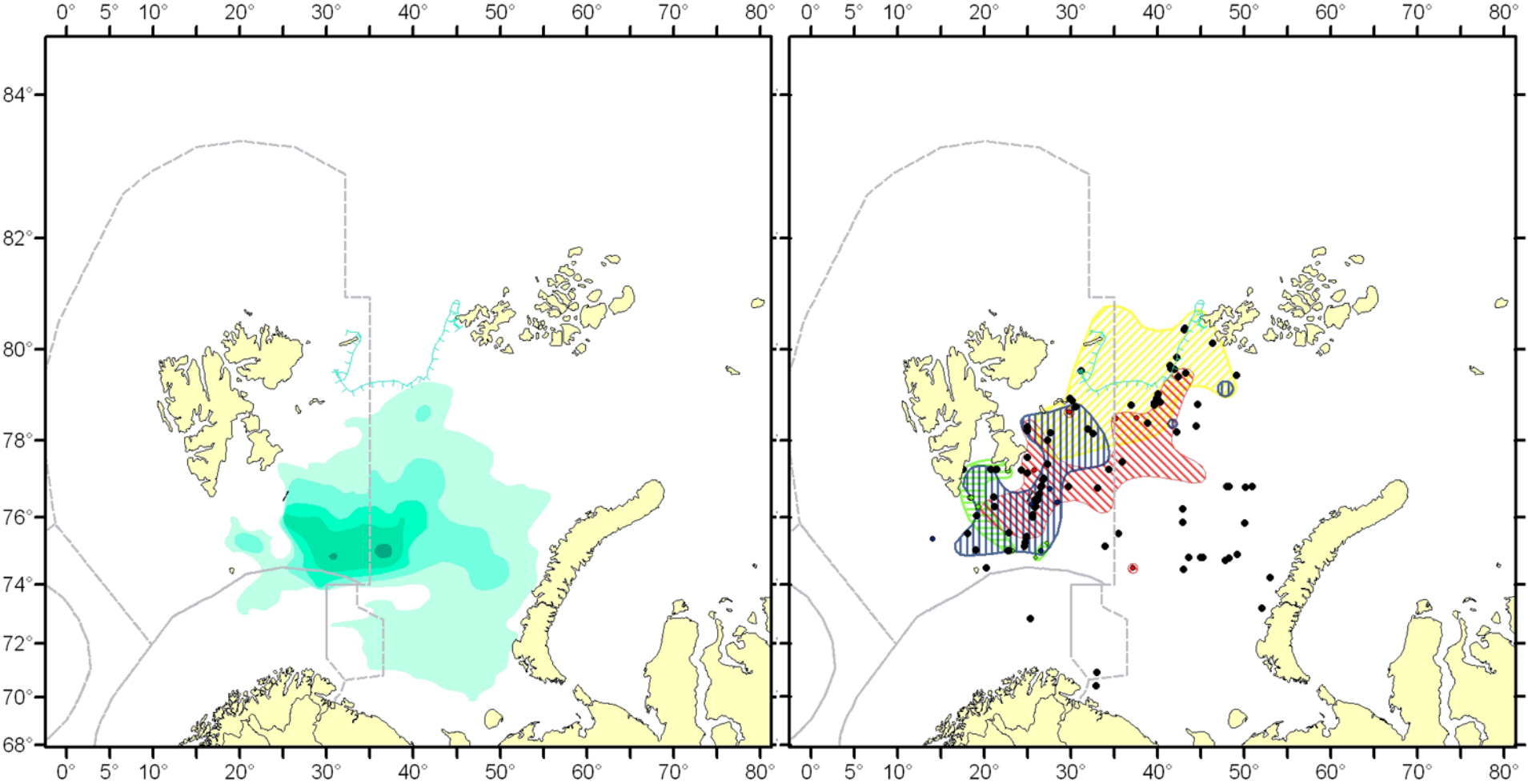

Distribution of capelin and marine mammals in the open part of the Barents Sea during autumn 2002.

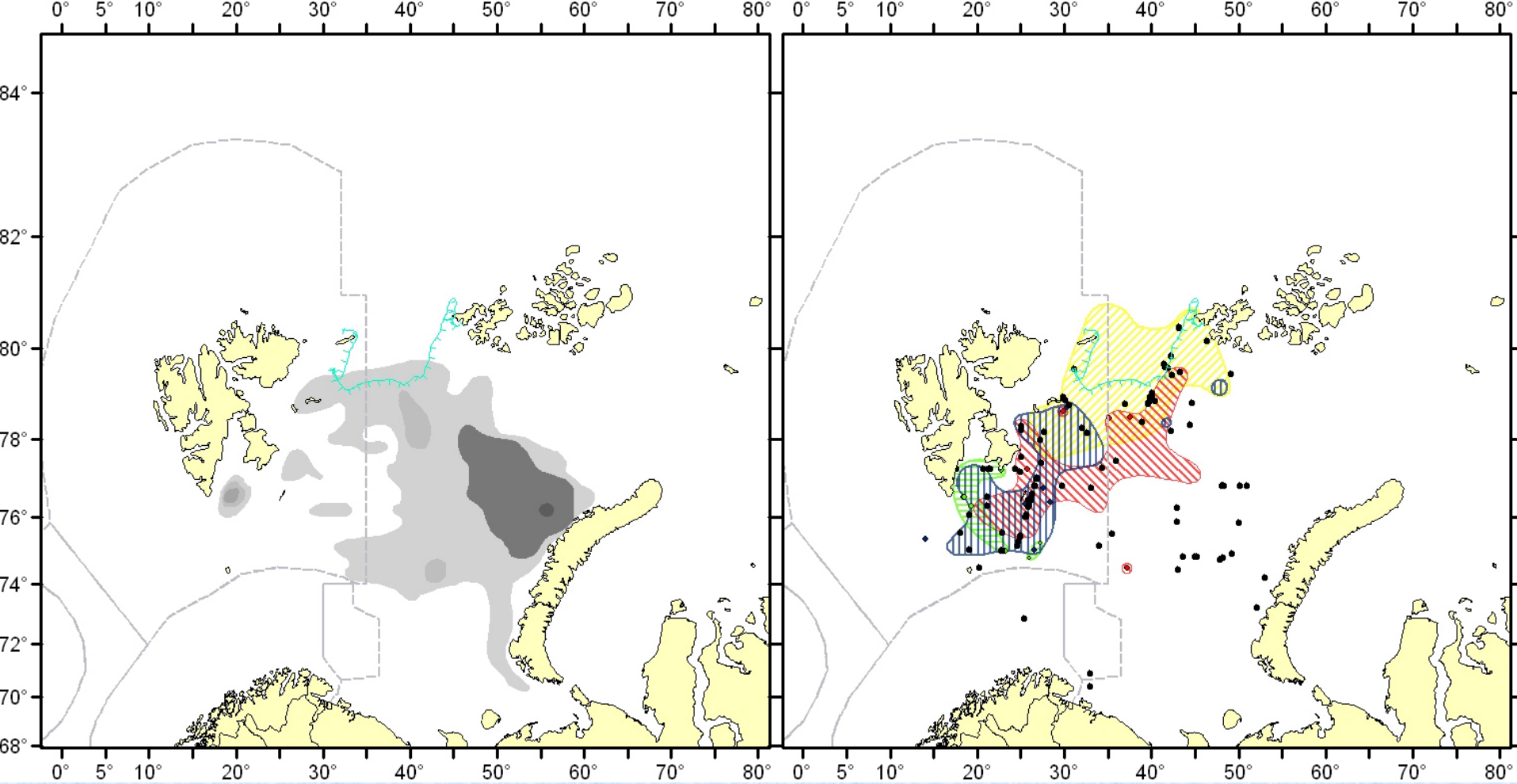

Distribution of polar cod and marine mammals in the open part of the Barents Sea during autumn 2002.

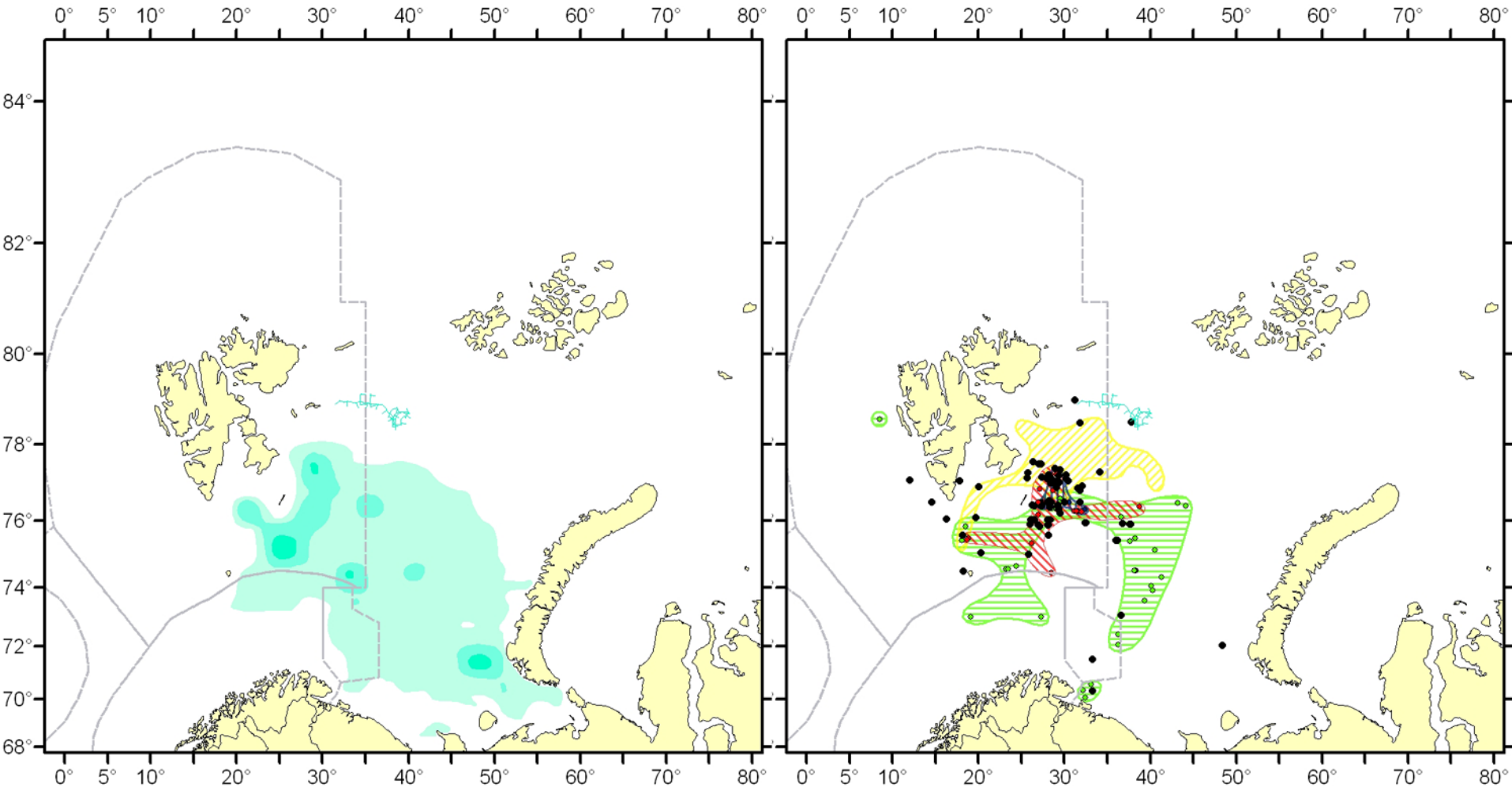

Distribution of capelin and marine mammals in the open part of the Barents Sea during autumn 2003.

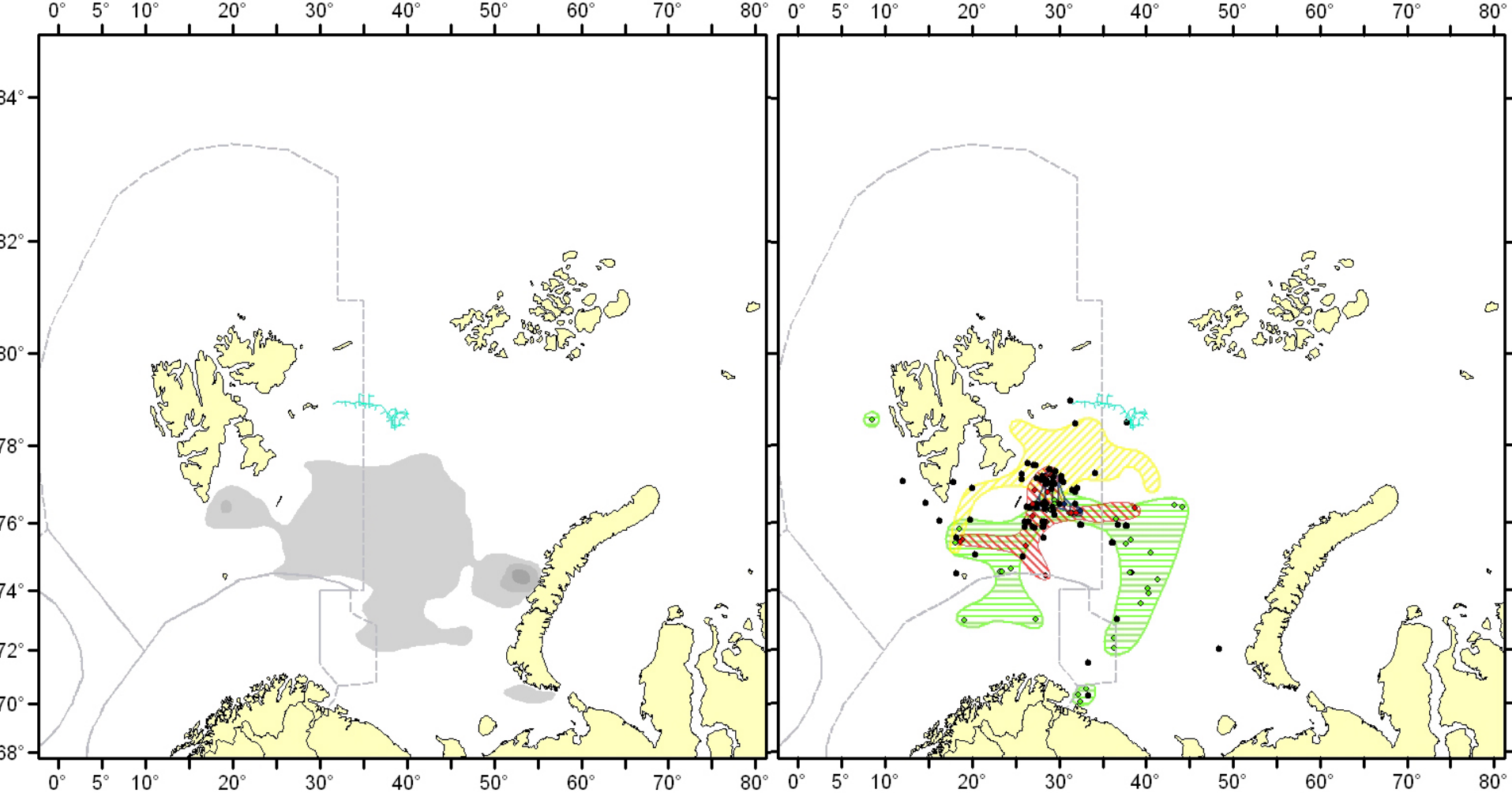

Distribution of polar cod and marine mammals in the open part of the Barents Sea during autumn 2003.

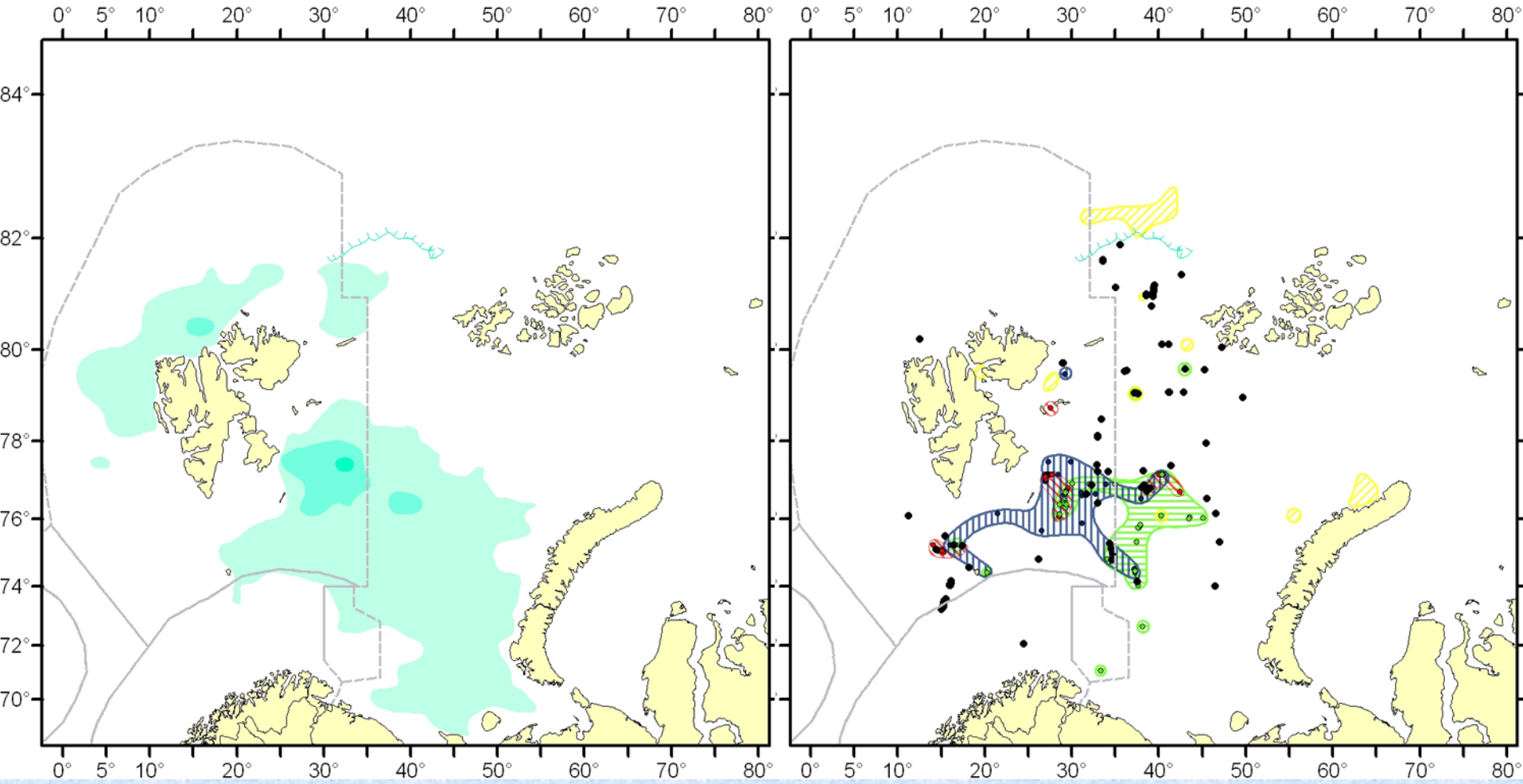

Distribution of capelin and marine mammals in the open part of the Barents Sea during autumn 2004.

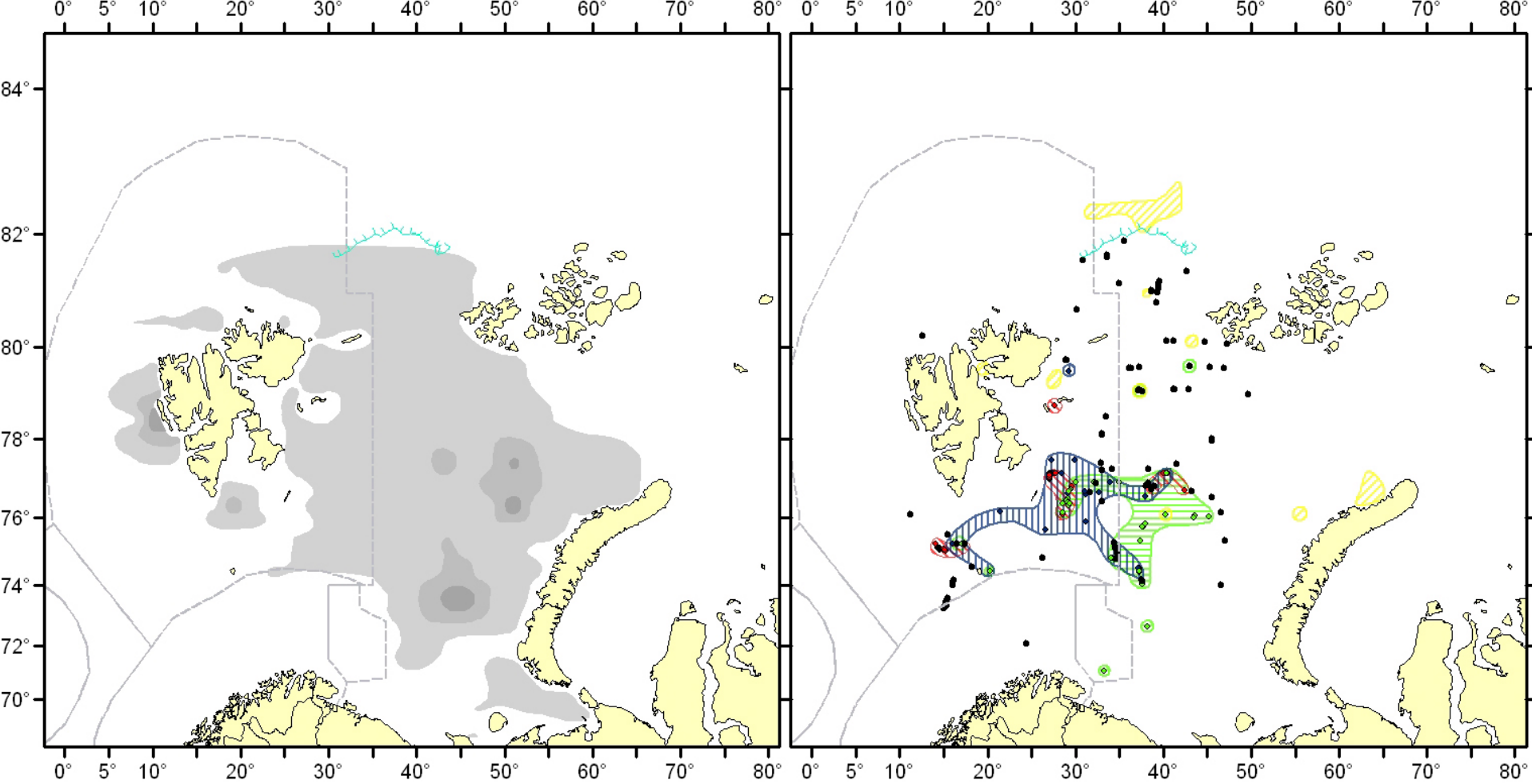

Distribution of polar cod and marine mammals in the open part of the Barents Sea during autumn 2004.

Main results of air surveys:

- - relative increase in numbers and extension of areal's size for humpback, minke whale and Atlantic white-beaked dolphin;
- - distribution of cetaceans in the Barents Sea in most cases depend of capelin's abundance, and more less than polar cod;
- - at present, the trophic role of marine mammals in the ecosystem of the Barents Sea maybe very considerable;
- - need further investigations of marine mammals of Barents Sea, especially nutrition, and special air surveys.